

Panasonic®

Operating Instructions

Color CCTV Camera

Model No. **WV-CW634S**

WV-CW634F

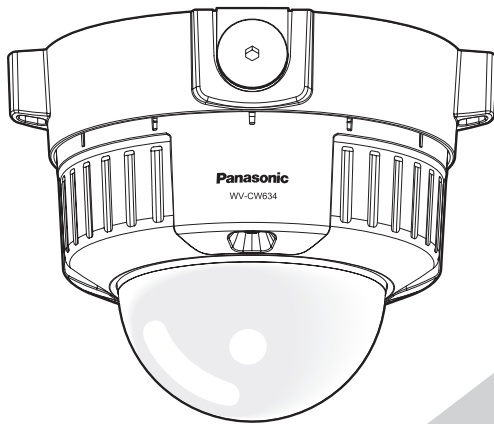

WV-CW634S

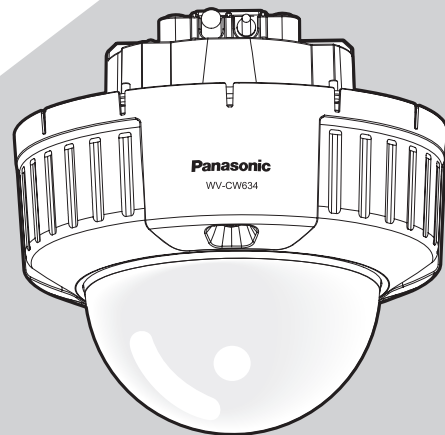

WV-CW634F

Before attempting to connect or operate this product,
please read these instructions carefully and save this manual for future use.

The model number is abbreviated in some descriptions in this manual.

Preface

About the user manuals

The operating instructions of the camera consist of 2 sets: these operating instructions (PDF) and Installation Guide.

This document explains how to configure the settings of the camera.

Refer to the installation guide for further information about how to install the camera.

Adobe® Reader® is required to read PDF. When the Adobe® Reader® is not installed on the PC, download the latest Adobe® Reader® from the Adobe web site and install it.

Trademarks and registered trademarks

Adobe, Acrobat Reader and Reader are either registered trademarks or trademarks of Adobe Systems Incorporated in the United States and/or other countries.

Contents

Preface	2	10. Synchronization method selection [SYNC]	18
About the user manuals	2	11. Privacy zone setting [PRIVACY ZONE].....	18
Trademarks and registered trademarks	2	12. Image stabilizer setting [STABILIZER]	19
Contents	3	13. Electronic zoom setting [EL-ZOOM]	19
About the setup menus	4	14. Upside-down setting [UPSIDE-DOWN]	20
List of setup menu.....	4	15. Lens distortion correction [LDC].....	20
Basic operation	5	Back focus setting [BACK-FOCUS SETUP].....	21
Screen transition diagram	6	Special menu setting [SPECIAL SETUP]	23
Camera title setting [CAMERA ID].....	7	16. Chroma level adjustment [CHROMA GAIN]	23
Camera operation setting [CAMERA SETUP].....	8	17. Aperture level adjustment [AP GAIN].....	23
1. Register a scene file [SCENE1/SCENE2].....	8	18. Pedestal level adjustment [PEDESTAL]	23
2. Light quantity control method selection [ALC/ELC]	8	19. Chroma phase (hue) adjustment [HUE]	23
About Super Dynamic 6 Functions	9	20. Display Settings [DISPLAY]	23
SUPER-D6 setting	9	21. Pixel compensation [PIX OFF]	24
About the highlight compensation (HLC) function.....	10	22. Communication setting [COMMUNICATION]	24
About the fog compensation function	11	23. Default resetting [CAMERA RESET]	24
3. Electronic shutter setting [SHUTTER]	11	24. Serial number viewing [SER.NO.]	24
4. Gain control setting [AGC]	11	Camera language selection [LANGUAGE SETUP].....	25
5. Electronic sensitivity enhancement setting		Shortcut operation	26
[SENS UP]	11		
6. White balance setting [WHITE BAL]	12		
Manual fine adjustment of white balance	13		
7. Digital noise reduction function setting [DNR].....	13		
8. Black-and-white mode setting [D&N (IR)]	13		
9. VMD setting [VMD]	15		
Setting of motion detection	15		
Setting of scene change detection	17		
Camera system setting [SYSTEM SETUP]	18		

About the setup menus

Performing each setting item in the setup menu should be completed in advance to use this unit.
Perform the settings for each item in accordance with the conditions of the camera shooting area.

List of setup menu

Setup item	Description
CAMERA ID	This item specifies the camera title. The camera title that indicates the camera location and other information about the camera is created with alphanumeric characters and symbol, and then displayed on the screen.
CAMERA	Performs the camera operation settings.
SCENE 1/ SCENE 2	Selects a scene file. It is possible to register and save the settings as a scene file in case that it is necessary to change the settings such when shooting at night.
ALC/ELC	Selects the method of controlling the quantity of light in accordance with the lens to be used.
SHUTTER	Specifies the electronic shutter speed.
AGC	Specifies gain adjustment.
SENS UP	Specifies electronic sensitivity enhancement.
WHITE BAL	Specifies white balance adjustment.
DNR	Selects the level of the digital noise reduction function.
D&N (IR)	Performs each setting regarding the black-and-white mode such as switching between color and black-and-white images.
VMD	Performs settings regarding VMD (Video Motion Detection)
SYSTEM	Performs the settings regarding the camera system such as synchronization and privacy zone.
SYNC	Specifies the synchronization type.
PRIVACY ZONE	Hides undesired portions in the camera shooting area.
STABILIZER	Decides whether or not to enable the image stabilizer.
EL-ZOOM	Switches the electronic zoom on and off.
UPSIDE-DOWN	Flips the camera images vertically or horizontally.
LDC	Adjusts the lens distortion correction to convert the image so that it matches the square monitor.
BACK FOCUS	Selects the back focus setting type and performs fine adjustment.
SPECIAL	
CHROMA GAIN	Adjusts the chroma level (color density).
AP GAIN	Adjusts the aperture level.
PEDESTAL	Adjusts the pedestal (brightness) level.
HUE	Adjust the chroma phase (hue).
DISPLAY	Performs the image display setting.
PIX OFF	Corrects image defects such as flaws.
COMMUNICATION	Performs the communication setting of the system with a receiver into which this unit is integrated.
CAMERA RESET	Restores the settings in the setup menu to the default settings.
SER.NO.	Displays the serial number of this unit.
LANGUAGE	Selects a language to be used in the setup menu.

Basic operation

The operations in the setup menu are performed with the operation buttons after calling up the setup menu on the connected video monitor.

The description below explains how to operate the setup menu basically.

Screenshot 1

Hold down the [SET] button for about 2 seconds to call up the top screen of the setup menu.

```
MODEL WV-CW634
CAMERA ID OFF
CAMERA 1
SYSTEM 1
BACK-FOCUS 1
SPECIAL 1
LANGUAGE 1

END SETUP DISABIE
```

Screenshot 2

The setup mode changes to “ENABLE”, and the setup menu becomes ready to be set.

```
MODEL WV-CW634
CAMERA ID OFF
CAMERA 1
SYSTEM 1
BACK-FOCUS 1
SPECIAL 1
LANGUAGE 1

END SETUP ENABLE
```

Screenshot 3

The selected setup screen in the setup menu appears on the screen.

```
**CAMERA SETUP**
SCENE1
ALC/ELC ALC 1
SHUTTER OFF
AGC ON(HIGH)
SENS UP OFF
WHITE BAL ATW1
DNR HIGH
D&N(IR) AUTO1
VMD OFF

RET TOP END
```

Note:

- If the top screen of the setup menu is called up with the [SET] button while the camera is operated, the setup mode is always “DISABLE” to prevent operation errors. To perform settings in the setup menu, change the setup mode to “ENABLE”.
- The cursor is a reversely highlighted part.

Step 1

Press the [UP] or [DOWN] button to move the cursor to “END”.

Step 2

Press the [RIGHT] button to move the cursor to “SETUP”, and press the [SET] button to change the setup mode from “DISABLE” to “ENABLE”.

Step 3

Move the cursor to the item to be set, and press the [SET] button.

Step 4

Perform the settings for each item.

- **Selection of setting item:**
Press the [UP] or [DOWN] button to move the cursor.
- **Change of settings:**
Press the [RIGHT] or [LEFT] button.
- **Display of advanced setup screen:**
Press the [SET] button when “” is attached to the target setting item.
- **Return to previous setup screen:**
Move the cursor to “RET” and press the [SET] button.
- **Return to the top screen:**
Move the cursor to “TOP” and press the [SET] button, to display the top screen of the setup menu.

Step 5

Move the cursor to “END” and press the [SET] button to return to the camera image screen, or wait about 5 minutes and the setup menu will automatically close.

Screen transition diagram

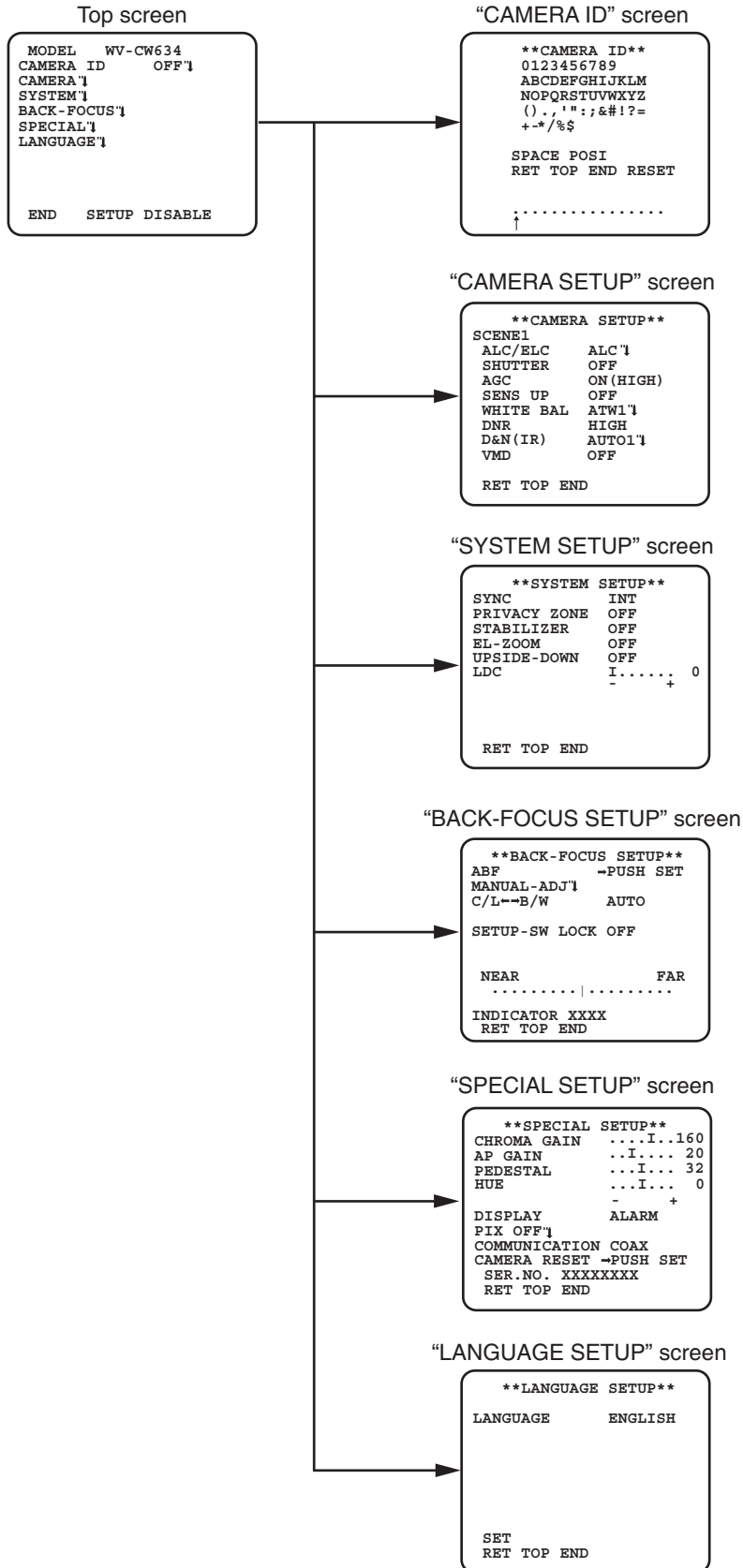

Camera title setting [CAMERA ID]

This item specified the camera title. The camera title that indicates the camera location and other information about the camera is created with alphanumeric and symbols, and is displayed on the screen. The camera title is named with up to 16 characters. Follow the procedure below to specify the camera title.

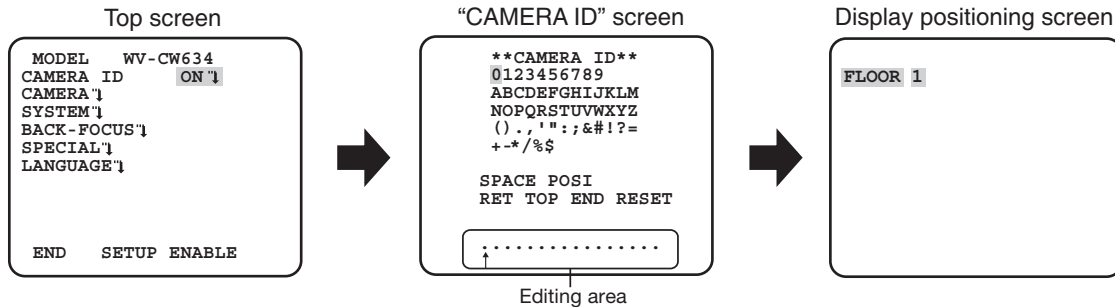

Step 1

Select "ON" for "CAMERA ID", and then press the [SET] button.
→ The "CAMERA ID" screen appears.

Important:

- When "CAMERA ID" is set to "OFF", the camera title does not appear even after setting the camera title.

Step 2

Move the cursor to the target item with use of the [UP], [DOWN], [RIGHT] and [LEFT] buttons, and press the [SET] button to enter the character.
→ The entered characters are displayed in the editing area.

<Character entry>

- To revise a character, move the arrow (↑) in the editing area to a wrong character with use of the [RIGHT] or [LEFT] button, and enter a correct character.
- To enter a blank, move the cursor to "SPACE" and press the [SET] button.
- To delete all the entered characters, move the cursor to "RESET" and press the [SET] button.

Step 3

Move the cursor to "POSI" and press the [SET] button after title entered.
→ The display positioning screen appears.

Step 4

Press the [UP], [DOWN], [RIGHT] and [LEFT] buttons to decide the title position and press the [SET] button.
→ The title position is specified.

Camera operation setting [CAMERA SETUP]

The following describes the camera operation settings. The following settings can be configured on the "CAMERA SETUP" screen displayed from the top screen.

Refer to page 5 for how to call up the screen.

The settings configured on the "CAMERA SETUP" screen will be saved as a scene file.

1. Register a scene file [SCENE1/SCENE2]

There are two scene modes. Change between the scene files can be made by shortcut operation. (☞ page 26).

The default setting is "SCENE1".

Screen when "SCENE1" is selected

```

**CAMERA SETUP**
SCENE1
ALC/ELC    ALC`1
SHUTTER    OFF
AGC        ON(HIGH)
SENS UP    OFF
WHITE BAL  ATW1`1
DNR        HIGH
D&N(IR)    AUTO1`1
VMD        OFF

RET TOP END
    
```

Screen when "SCENE2" is selected

```

**CAMERA SETUP**
SCENE2
ALC/ELC    ALC`1
SHUTTER    OFF
AGC        ON(HIGH)
SENS UP    OFF
WHITE BAL  ATW1`1
DNR        HIGH
D&N(IR)    AUTO1`1
VMD        OFF

RET TOP END
    
```

Step 1

After confirming that "SCENE1" is selected, configure the settings of "ALC/ELC" through "VMD". (☞ page 8-17)

To change the scene files, go to step 2.

Step 2

Move the cursor to "SCENE1" and press the [RIGHT] or [LEFT] button to select "SCENE2".

→ The screen changes and displays "SCENE2".

Step 3

Set the items you want to change.

The number displayed at the right side of the title on each setting screen indicates a scene file number.

Step 4

Move the cursor to "SCENE2" and press the [RIGHT] or [LEFT] button to select "SCENE1" to resume normal operation.

```

**ALC CONT** (1)
BACK LIGHT COMP
SUPER-D6    ON
HLC         ---
FOG COMP    ---

LEVEL       .I..... 0
            -.....+

RET TOP END
    
```

Scene file number

2. Light quantity control method selection [ALC/ELC]

The method of controlling the quantity of light is selected from the following in accordance with the lens to be used.

ALC (default): The iris of the lens is automatically adjusted in accordance with the brightness of a subject. Select "ALC" when using an ALC lens.

ALC+: Controls the quantity of light with a combination of the electronic shutter and auto iris. This selection is suitable at shooting a bright subject such as an outdoor subject with auto iris lens. Be aware that flicker may occur when a subject is under fluorescent lighting.

ELC: Controls the quantity of light with the electronic shutter. This selection is suitable for use of a lens with fixed iris or manual iris.

About Super Dynamic 6 Functions

If there is high contrast between the bright and dark areas in a shooting zone, the dark area becomes less visible because the camera adjusts the iris in accordance with the bright area. Conversely, adjusting the lens brightness for the darker areas causes the brighter areas to become washed out. The SUPER DYNAMIC 6 function digitally combines an image that is set up for a clear view of the brighter areas with an image that is set up for a clear view of the darker areas, creating a final image that preserves overall detail.

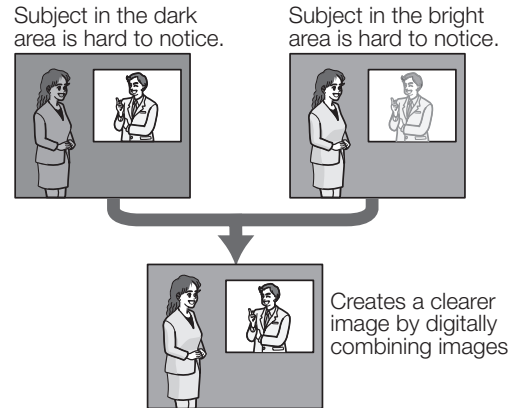

SUPER-D6 setting

When “ALC/ELC” is set to “ALC”, the SUPER-D6 function is available. Follow the procedure below.

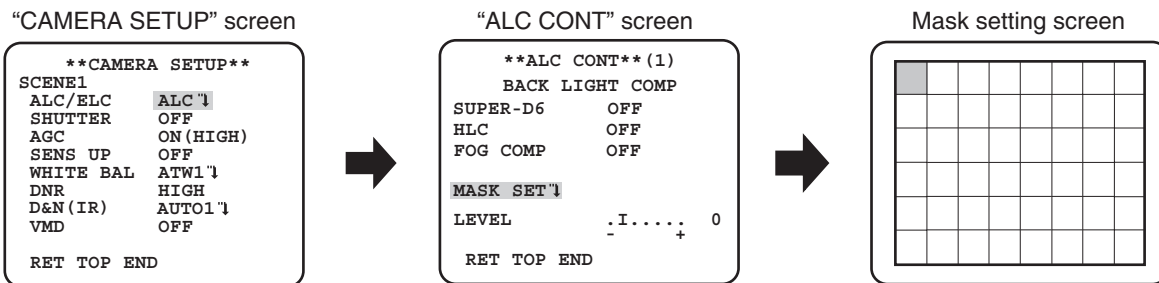

Step 1

Set “ALC/ELC” to “ALC”, and press the [SET] button.
→The “ALC CONT” screen appears.

Note:

- When “ALC/ELC” is set to “ELC” or “ALC+” and the [SET] button is pressed, the “ELC CONT” or “ALC+ CONT” screen will appear.
- When “ELC” or “ALC+” is selected, the SUPER-D6 function is disabled. “---” appears and “OFF” is selected. (Go to Step 3)

Step 2

Move the cursor to “SUPER-D6” and select the “ON” or “OFF”.

ON (default): Activates the SUPER-D6 function. (Go to Step 6)

OFF: Deactivates the SUPER-D6 function. (Go to Step 3)

Note:

- Once the “SUPER-D6” function is set to “ON”, the settings of the following items will be restricted.
SHUTTER: It can only be set to “OFF” or “1/100”.
SENS UP: It can only be set to “OFF” or “AUTO”.
- Once the “SUPER-D6” function is set to “ON”, a shadow (black line) may appear at the border of the brighter part and darker part. This is not a fault.
- When flickering or noise is observed frequently due to the illumination of light, select “OFF”.
 - When flickering or color deterioration is observed
 - When noise is produced in a bright area on the screen
- Once the “SUPER-D6” function is set to “ON”, “---” is displayed for “HLC” and “FOG COMP”. In this case, the “HLC” and “FOG COMP” functions cannot be set.

Step 3

When the SUPER-D6 function is set to “OFF”, bright areas of an image are masked to facilitate the visibility of dark areas.
Move the cursor to “MASK SET” and press the [SET] button.
→ The mask setting screen appears.

Step 4

Press the [UP], [DOWN], [RIGHT] and [LEFT] buttons to move the flashing cursor to the area to be masked and press the [SET] button.

When the selected area is masked, the masked area will start blinking (between stripes and white). When the flashing cursor is moved to other areas, the masked area will be displayed in white.

Repeat the above procedure to mask other areas as necessary.

Note:

- To cancel the masking, select the masked area to be canceled, and then press the [SET] button. The masked area will be deleted.

Step 5

Hold down the [SET] button for more than 2 seconds after completion of masking.
→ Return to the previous menu.

Step 6

Move the cursor to “LEVEL” and press the [RIGHT] or [LEFT] button to adjust the level.

About the highlight compensation (HLC) function

This function is a backlight compensation technology that enables the camera to obtain clear images in a strong light environment. When “SUPER-D6” is set to “ON”, this function cannot be set.

Available options: ON (1)/ON (2)/OFF

ON (1): When the camera faces the light source, this function can be used to block strong light so as to reduce over exposure as much as possible and retain lots of screen details.

The mask area has three options: small (S), medium (M) and large (L), which are used to adjust the area of the mask zone.

When the mask level cursor moves towards the “+” direction, the mask color becomes pale; when the mask level cursor moves towards the “-” direction, the mask color becomes dark.

ON (2): When the camera faces the light source, strong light can be effectively suppressed and screen details can be retained to the maximum extent.

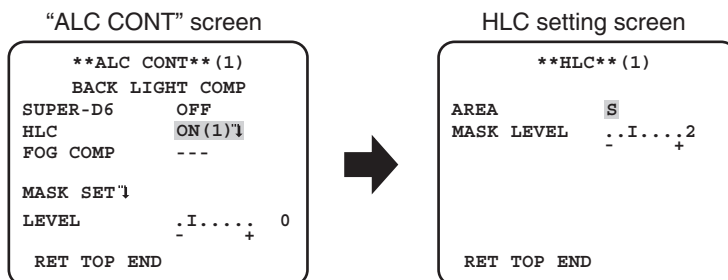

Note:

- According to different highlight parts on the screen, different HLC functions may be provided.
- The HLC function can be enabled only when the brightness area exceeds the normal specification.
- When the HLC function is set to “ON (1)” or “ON (2)”, “FOG COMP” is displayed as “---” and the fog compensation function cannot be set.
- After “SUPER-D6” switches from “ON” to “OFF”, “HLC” and “FOG COMP” are displayed as “OFF”.

About the fog compensation function

This function enables the camera to obtain clear images in hazy weather. When “SUPER-D6” or “HLC” is set to “ON”, this function is not available.

Adjust the amplitude of fog compensation. When the cursor moves towards the “+” direction, the fog compensation level increases; when the cursor moves towards the “-” direction, the fog compensation level decreases.

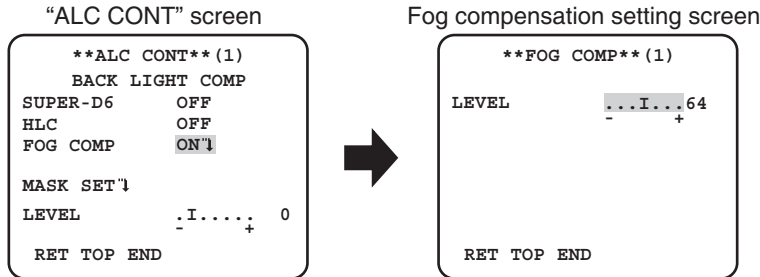

3. Electronic shutter setting [SHUTTER]

The variation in shutter speed allows users to perform the following.

- Increased shutter speed prevents blurring fast-moving subjects.
- If flicker is observed under fluorescent lighting of 50 Hz, selection of “1/100” for the speed can reduce flicker.

The shutter speed is selectable from the following.

OFF (1/60) (default), **1/100**, **1/250**, **1/500**, **1/1000**, **1/2000**, **1/4000**, **1/10000**, **1/120000**

Note:

- When “ALC/ELC” is set to “ELC” or “ALC+”, “---” appears and the shutter function cannot be activated.
-

4. Gain control setting [AGC]

Select a gain control setting from the following.

ON (HIGH) (default)/**ON (MID)** /**ON (LOW)**: Automatically increases the gain to make the screen brighter when the illuminance of the subject becomes darker.

HIGH, MID and LOW indicate the gain level.

OFF: Does not increase the gain.

Note:

- When “SENS UP” is set to the AUTO mode, “AGC” cannot be set to “OFF”.
-

5. Electronic sensitivity enhancement setting [SENS UP]

Use of the electronic sensitivity enhancement function increases the light sensitivity of the CCD, and accordingly the image becomes brighter. The magnification is unchanged for selection of FIX, and the magnification is automatically adjusted in accordance with the illuminance of a photographic subject for selection of AUTO.

The magnification of the electronic sensitivity is selectable from the following.

Setting of the SUPER-D6 function restricts the available setting range.

When the SUPER-D6 function is set to “OFF”:

OFF (default)/**X2 AUTO**/**X4 AUTO**/**X6 AUTO**/**X10 AUTO**/**X16 AUTO**/**X32 AUTO**/**OFF**/**X2 FIX**/**X4 FIX**/**X6 FIX**/**X10 FIX**/**X16 FIX**/**X32 FIX**/**X64 FIX**/**X128 FIX**/**X256 FIX**/**X512 FIX**

When the SUPER-D6 function is set to “ON”:

OFF (default)/**X2 AUTO**/**X4 AUTO**/**X6 AUTO**/**X10 AUTO**/**X16 AUTO**/**X32 AUTO**

Note:

- When “ALC/ELC” is set to “ELC” or “ALC+”, only the AUTO mode is enabled.
 - When “SHUTTER” is set to options other than “OFF” or “1/100”, the electronic sensitivity enhancement setting cannot be performed and “---” appears.
 - When the magnification of “SENS UP” is increased, the screen becomes coarser, more whitish, or more flawed. However, this phenomenon is normal.
-

6. White balance setting [WHITE BAL]

The white balance adjustment is selectable from the following.

ATW1 (default): Activates the automatic color temperature tracking mode.

The camera continuously check the color temperature of the light source and automatically adjusts the white balance. The adjustment of the color temperature ranges from approx. 2700 K to 6000 K.

ATW2: Activates the sodium lamp automatic color temperature tracking mode. The camera automatically achieves an optimal white balance under the sodium lamp. The adjustment of the color temperature ranges from approx. 2000 K to 6000 K.

AWC: Activates the automatic white balance control mode. This adjustment is suitable for a location where a light source is stable. The adjustment of the color temperature ranges from 2000 K to 10000 K. When “AWC” is selected, the white balance needs to be adjusted.

Note:

- If the situation meets one of the followings, color may not be accurately reproduced.
 - The subject is mostly highly-colored.
 - The photographic scene is under the bright blue sky or at nightfall.
 - The illumination of the light illuminating the subject is insufficient.
-

When “AWC” is selected, follow the steps below to adjust the white balance.

“CAMERA SETUP” screen

```
  **CAMERA SETUP**
SCENE1
ALC/ELC  ALC 1
SHUTTER  OFF
AGC      ON(HIGH)
SENS UP  OFF
WHITE BAL AWC→PUSH SET
DNR      HIGH
D&N(IR)  AUTO1 1
VMD      OFF

RET TOP END
```

Step 1

Set “WHITE BAL” to “AWC” and press the [LEFT] button to change to “AWC → PUSH SET”.

Step 2

Press the [SET] button and adjust the white balance. “AWC → PUSH SET” is reversely highlighted during adjustment. When the reversely highlighted display is restored, the white balance adjustment is completed.

Step 3

Press the [RIGHT] button to select “AWC”. Refer to next page for fine adjustment of the white balance.

Note:

- The adjustment of the color temperature ranges from approx. 2000 K to 10000 K. If the range is out of this adjustment range or lighting directed to a subject is too dark, the white balance may not be adjusted. In such a case, “AWC → PUSH SET” stays reversely highlighted.
-

Manual fine adjustment of white balance

The white balance is manually fine adjusted after white balance automatic adjustment in the automatic color temperature tracking mode (ATW1, ATW2) or automatic white balance control mode (AWC).

Follow the procedures below.

“CAMERA SETUP” screen

```
**CAMERA SETUP**
SCENE1
ALC/ELC  ALC 1
SHUTTER  OFF
AGC      ON (HIGH)
SENS UP  OFF
WHITE BAL ATW1 1
DNR      HIGH
D&N (IR) AUTO1 1
VMD      OFF
RET TOP END
```



Fine adjustment screen

```
**ATW1** (1)
R      ···I··· 0
      -      +
B      ···I··· 0
      -      +
AREA 1
RET TOP END
```



Area setting screen

```
**ATW1 AREA** (1)
POSITION →PUSH SET
RESET
RET TOP END
```

Step 1

Set “WHITE BAL” to “ATW1”, “ATW2” or “AWC” and press the [SET] button.

→ The fine adjustment screen appears.

Step 2

Move the cursor to “R” and “B” and press the [RIGHT] or [LEFT] button to fine adjust the level for each. “R” stands for red and “B” stands for blue.

When the level indicator moves in the “+” direction, the color becomes deeper, and when the level indicator moves in the “-” direction, the color becomes lighter.

Step 3

Move the cursor to “AREA” and press the [SET] button to enter “AREA” setting screen.

The area to detect white area of white balance can be set on the area setting screen. The area to detect white area of white balance is displayed full-screen by default.

Step 4

Move the cursor to “POSITION” and press the [SET] button.

Step 5

Press the [UP], [DOWN], [RIGHT] and [LEFT] buttons to move to the upper-left part of the area to be set, and press the [SET] button.

Step 6

Press the [UP], [DOWN], [RIGHT] and [LEFT] buttons to move to the lower-right part of the area to be set, and press the [SET] button.

7. Digital noise reduction function setting [DNR]

The digital noise reduction function reduces noise automatically under the condition of low illuminance.

The effect level of the noise reduction function is selectable from the following.

LOW: Low level of noise reduction (small residual image)

HIGH (default): High level of noise reduction (large residual image)

8. Black-and-white mode setting [D&N (IR)]

The settings relating to the black-and-white mode can be configured.

Follow the procedure below

“CAMERA SETUP” screen

```
**CAMERA SETUP**
SCENE1
ALC/ELC  ALC 1
SHUTTER  OFF
AGC      ON(HIGH)
SENS UP  OFF
WHITE BAL ATW1 1
DNR      HIGH
D&N (IR) AUTO1 1
VMD      OFF
RET TOP END
```



“D&N (IR)” screen

```
**D&N (IR) ** (1)
AUTO1
LEVEL    HIGH
DURATION TIME 1.1
          S L
BURST (BW) ON
RET TOP END
```

Step 1

Move the cursor to “D&N (IR)” and select the mode from the following.

AUTO1 (default): Automatically switches between color and black-and-white images in accordance with the illuminance. The black-and-white mode is selected for dark images, and the color mode is selected for bright images.

AUTO2: Used a near-infrared light source at night time.

ON: Displays black-and-white images.

OFF: Displays color images.

Note:

- When “AUTO1” or “AUTO2” is selected, it is recommended to set “AGC” to “ON”.
- If a subject is always moving or the screen is occupied with a uniform color, brightness determination may not be performed successfully because the brightness is merely determined by information from the CCD image sensor. When “AUTO2” is selected, the wave length of the light source shall be 800 nm or longer.

Step 2

Press the [SET] button.

→ The “D&N (IR)” screen appears.

Step 3

Move the cursor to “LEVEL” and select a brightness level at which switching between color and black-and-white images is performed from the following.

LOW: Switches from color to black-and-white images when the ambient illuminance of the camera is less than 0.1 lx.

HIGH (default): Switches from color to black-and-white images when the ambient illuminance of the camera is less than 0.2 lx.

Note:

- The switching illuminance level varies with subjects, light sources, and lenses.
- The switching illuminance level varies in accordance with AGC setting. (☞ page 11)
- The switching illuminances described above are reference values. The switching illuminance shall be decided based on the actual installation environment.
- There may be repeated switching between color and black-and-white images depending on the setting and environment.

Step 4

Move the cursor to “DURATION TIME” and select a time for switching between color and black-and-white images from the following.

2 seconds - 10 seconds (default) - 30 seconds - 60 seconds

(S)

(L)

Step 5

Move the cursor to “BURST (BW)”, and decide whether or not to provide a burst signal output in the black-and-white mode.

ON (default): Provides a burst signal output.

OFF: Does not provide any burst signal output.

Note:

- Images may not be displayed appropriately without burst signals when camera images are displayed in the black-and-white mode depending on a monitor or VTR model to be used. In such a case, set the burst signal output to “ON”.
-

9. VMD setting [VMD]

The VMD function allows the camera to detect motion and scene change with the camera. Detection of motion or scene change with the camera can be announced by issuing an alarm signal.

Important:

- The following circumstances may result in detection failure or false detection. Use the camera after adjusting the detection area and sensitivity.
 - Not enough difference in brightness between the background and the moving photographic subject, or significant changes in brightness
 - Dirt or water drops on the lens
 - Insufficient brightness, for example, when shooting at night
 - The subject is moving straight at the camera
 - The subject is moving too fast or too slow
 - The subject is too small or too large
 - There are too many moving objects
 - Light reflected through a window or from a road surface
 - The camera is shaking
 - Entry of outside light, such as sunlight or the headlights of a car
 - Flickering fluorescent light
 - Subject change detection may fail in the following cases.
 - The lens is partially covered or covered with a transparent item
 - The photographic subjects before and after changing the camera direction are similar
 - False detection may occur for approx. 1 minute after turning on the power, after completing settings in the SETUP menu, or after changing the camera view angle.
 - Motion detection is the detection function within the screen range for electronic zoom of 1x.
-

Setting of motion detection

Move the cursor to “VMD”, press the [RIGHT] or [LEFT] button to select “MOTION DET”.

“CAMERA SETUP” screen

```
  **CAMERA SETUP**
SCENE1
ALC/ELC  ALC`1
SHUTTER  OFF
AGC      ON(HIGH)
SENS UP  OFF
WHITE BAL ATW1`1
DNR      HIGH
D&N(IR)  AUTO1`1
VMD      MOTION DET`1
RET TOP END
```



“MOTION DET” screen

```
  **MOTION DET** (1)
LEVEL    .....I... 20
          - +
DWELL TIME 2S
DISPLAY MODE`1
ALARM      OFF
MASK SET `1
RET TOP END
```

Step 1

Move the cursor to “MOTION DET” and press the [SET] button.

→ The “MOTION DET” screen appears.

Step 2

Move the cursor to “MASK SET” and press the [SET] button.

→ The mask setting screen appears.

"MOTION DET" screen

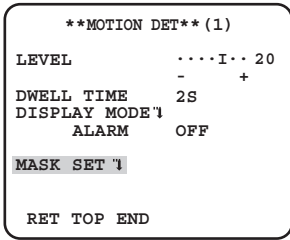

Mask setting screen

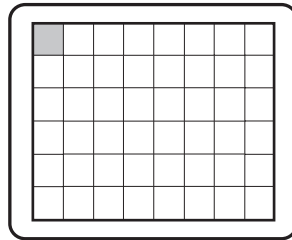

In the masked area, no alarm will be issued even if a moving object is detected. The masked area is set in the same way as the masked area setting in "Light quantity control method selection". (page 9)

Step 3

Hold down the [SET] button for more than 2 seconds after completion of masking.
→ Return to the previous menu.

Step 4

Move the cursor to "ALARM" and press the [RIGHT] and [LEFT] buttons to select "ON" or "OFF".

ON: Outputs alarm signal when in display mode. Actions may be confirmed through the motion detection mode when a moving object is detected.

OFF (default): Does not output alarm signal when in display mode.

Step 5

Move the cursor to "DISPLAY MODE" and press the [SET] button.

→ The display mode screen appears.

If a moving object is detected in the set area, the area will be reversely highlighted. Hold down the [SET] button for more than 2 seconds to return.

"MOTION DET" screen

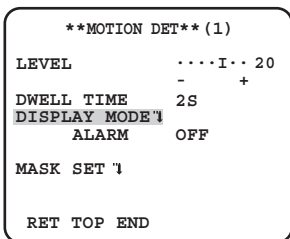

Display mode screen

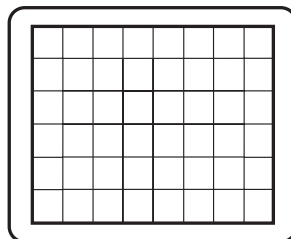

Step 6

Move the cursor to "LEVEL" and press the [RIGHT] or [LEFT] button to adjust the level.
Repeat step 5 and 6 to adjust to optimal level.

Step 7

Move the cursor to "DWELL TIME" and select the dwell time from the following. (unit: seconds)

2S (default)/5S /10S /30S

Alarm signal will be issued once a continuously moving object is detected within the specified time.

Setting of scene change detection

This function detects a change in the subject state that occurs by covering the camera with a cloth, a cap, or others, or by changing the camera direction largely.

Follow the procedure below.

“CAMERA SETUP” screen

```
  **CAMERA SETUP**
SCENE1
ALC/ELC  ALC 1
SHUTTER  OFF
AGC      ON(HIGH)
SENS UP  OFF
WHITE BAL ATW11
DNR      HIGH
D&N(IR)  AUTO11
VMD      SCENE CHANGE
RET TOP END
```

Step 1

Move the cursor to “VMD” and press the [RIGHT] or [LEFT] button to select “SCENE CHANGE”.

Note:

- The Scene Change function is activated after exit from the menu.
-

Camera system setting [SYSTEM SETUP]

Performs the settings relating to the camera system such as synchronization and privacy zone. The following settings can be configured on the “SYSTEM SETUP” screen displayed from the top screen.

Refer to page 5 for how to call up the screen.

“SYSTEM SETUP” screen

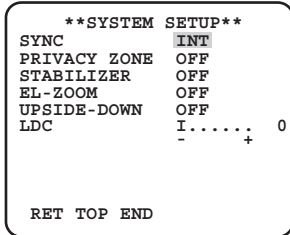

10. Synchronization method selection [SYNC]

This unit supports the following 2 types of synchronization methods, and one of the following is selected.

(1) Multiplexed vertical drive signal (VD2)

(2) Internal synchronization (INT) (default)

Input of a multiplexed vertical drive signal (VD2) automatically switches to the VD2 synchronization even if the camera is set to other than the VD2 synchronization method.

When the VD2 synchronization is not selected, internal synchronization can be selected.

11. Privacy zone setting [PRIVACY ZONE]

When undesired portions in the camera shooting area (on the screen) exist, those portions (privacy zone) can be set to be hidden. Up to 8 portions can be specified for the privacy zone.

ON (1): Grays the zone.

ON (2): Mosaics the zone.

OFF (default): Displays the zone normally.

Follow the procedure below to set the privacy zone.

Note:

- The privacy zone function is disabled at initializing the unit, i.e. right after turning on the power.
-

“SYSTEM SETUP” screen

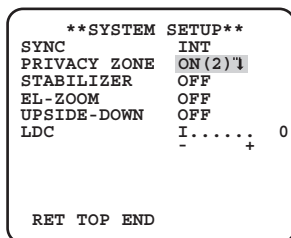

“ZONE NUMBER” screen

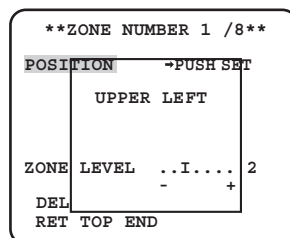

Step 1

Move the cursor to “PRIVACY ZONE”, select “ON (1)” or “ON (2)”, and press the [SET] button.

→ The “ZONE NUMBER” screen appears.

Step 2

Move the cursor to the number at the right of the title and select the zone number using the [RIGHT] or [LEFT] button.

Step 3

Move the cursor to “POSITION” and press the [SET] button.

Step 4

Press the [UP], [DOWN], [RIGHT] and [LEFT] buttons to determine the left upper position of the zone to be set and press the [SET] button.

Step 5

Press the [UP], [DOWN], [RIGHT] and [LEFT] buttons to determine the lower right position of the zone to be set and press the [SET] button.

→ An asterisk “*” will be displayed after the number and the zone setting will be saved.

Step 6

When “ON (2)” is selected for “PRIVACY ZONE”, the mosaic level may be adjusted. The mosaic level may be set through “ZONE LEVEL”. (Range: 1 to 4)

Note:

- To delete a zone, select the zone number and press the [SET] button after moving the cursor to “DEL”.
- To change the settings of a zone, select the zone number and repeat from step 3.

12. Image stabilizer setting [STABILIZER]

Whether or not to enable the image stabilizer is determined.

This function is effective for the case that the camera is installed at a place with slight shaking.

ON: Enables the image stabilizer.

OFF (default): Disables the image stabilizer.

Important:

- When “ON” is selected for the image stabilizer, the view angle becomes narrower and the resolution becomes lower. When “ON” is selected for the image stabilizer, check the view angle and resolution at camera installation.
- The image stabilizer function may not work for the following subjects or conditions.
 - Dark subject
 - Less contrasty subject (e.g. white wall)
 - Subject shaking at excessive speed
 - Large amplitude image shaking

13. Electronic zoom setting [EL-ZOOM]

Whether or not to use the electronic zoom is determined.

ON: Uses the electronic zoom.

OFF (default): Does not use the electronic zoom.

When “ON” is selected, the zoom factor and the panning/tilting settings can be configured.

Follow the procedure below.

“SYSTEM SETUP” screen

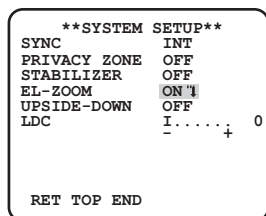

“EL-ZOOM” screen

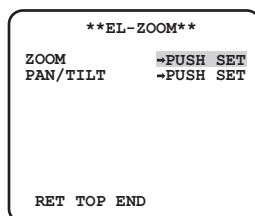

Zoom setting screen

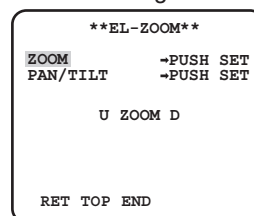

Pan/tilt setting screen

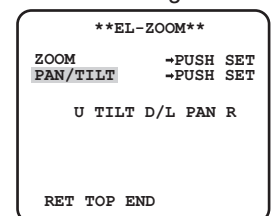

Step 1

Move the cursor to “EL-ZOOM” and select “ON” and press the [SET] button.
→ The “EL-ZOOM” screen appears.

Step 2

Move the cursor to “→ PUSH SET” of “ZOOM” and press the [SET] button.
→ The zoom setting screen appears.

Step 3

Adjust the angular field of view by changing the electronic zoom factor (up to 2x) using the [UP] or [DOWN] button, and press the [SET] button.

Note:

- When the zoom factor is incremented, resolution will be deteriorated.
-

Step 4

Move the cursor to “→ PUSH SET” of “PAN/TILT” and press the [SET] button.
→ The pan/tilt setting screen appears.

Step 5

Press the [UP], [DOWN], [RIGHT] and [LEFT] buttons to determine the position of the area to be set and press the [SET] button.
The position can be changed in the range of zoom factor set in the zoom setting screen.

14. Upside-down setting [UPSIDE-DOWN]

ON: The video image can be reversed upside down.

OFF (default): The video image cannot be reversed upside down.

15. Lens distortion correction [LDC]

The image may be distorted depending on the lens used and the zoom factor. By adjusting the lens distortion correction setting, the distorted image can be converted to match the square monitor and achieve effects desired by the user.

Note:

- Depending on the lens used, complete correction may not be achieved.
-

Back focus setting [BACK-FOCUS SETUP]

Selects the back focus setting type and performs fine adjustment. The following setting can be configured on the “BACK-FOCUS SETUP” screen displayed from the top screen. Refer to page 5 for how to call up the screen.

The lens adjustment (☞ Installation Guide) shall be performed before the back focus adjustment.

<Back focus adjustment>

The back focus adjustment is performed by changing the distance between the lens and focal point.

Follow the procedure below.

Important:

- The auto back focus function is used for back focus adjustment at installation and for focus correction at switching between the color and black-and-white modes after installation. This function is not a function that is supposed to be operated continuously such as the auto focus function.
 - When focus missing occurs due to secular change in the lens and installation environment or peripheral temperature change, the back focus adjustment is required again.
-

Note:

- The back focus adjustment can be also performed through the operation buttons. (☞ Installation Guide)
-

“BACK-FOCUS SETUP” screen

```
  **BACK-FOCUS SETUP**
  ABF          -PUSH SET
  MANUAL-ADJ↑
  C/L←→B/W    AUTO
  SETUP-SW LOCK OFF
  NEAR          FAR
  .....|.....
  INDICATOR XXXX FOCUSING
  RET TOP END
```

Step 1

Move the cursor to “PUSH SET” of “ABF” and press the [SET] button.

→ The auto back focus function provides back focus adjustment to automatically focus on a subject located in the center of the screen.

Step 2

To fine adjust the back focus, move the cursor to “MANUAL-ADJ”, press the [SET] button, and use the [RIGHT] or [LEFT] button to adjust the back focus manually.

Note:

- Pressing the [RIGHT] and [LEFT] buttons simultaneously for more than 2 seconds resets the back focus position to the CS mount default position.
 - The value of “INDICATOR” is a guide to adjust the back focus. The larger the value is, the sharper the image becomes.
-

Step 3

Move the cursor to “C/L ← → B/W” and select the back focus adjustment type from the following:

AUTO (default): Adjusts the back focus function automatically and corrects out of focus when switching between color and black-and-white images.

PRESET: Performs the preset movement to each specified back focus position when switching between color and black-and-white images. The preset position is the back focus position specified last time, which was automatically memorized for each of color images and black-and-white images.

FIX: Fixes the position after adjusting the back focus either automatically (ABF) or manually.

Step 4

Moving the cursor to “SETUP-SW LOCK” and selecting “ON” allow users to disable the back focus adjustment with the operation buttons (default: OFF).

Important:

- The following are recommendation for back focus setting in accordance with subjects.

For such case (subject conditions)	Select this (recommendation)	
	Back focus adjustment	“C/L ← → B/W” switching
• Normal subject	“ABF”	“AUTO”
• Frequently moving subj.	Fine adjustment with “MANUAL-ADJ” after “ABF” or “MANUAL-ADJ”	“PRESET” or “FIX”
• Subj. with remarkable illuminance change		
• Subj. with low illuminance		
• Too bright or reflective subj.		
• Subj. through a window		
• Place where the lens easily becomes dirty		
• Subj. with less contrast such as white wall		
• Subj. with remarkable depth		
• Subj. with heavy flicker		
• Subj. with horizontally parallel lines such as a shutter		

- We shall not responsible for any inconvenience, loss, or damage caused by the settings or results of the back focus function.

Special menu setting [SPECIAL SETUP]

The special menu setup is performed including the setting of the camera image quality and the communication configuration when a receiver is used. The following settings are to be configured on the “SPECIAL SETUP” screen displayed from the top screen. Refer to page 5 for how to call up the screen.

“SPECIAL SETUP” screen

```
**SPECIAL SETUP**
CHROMA GAIN  ...I...160
AP GAIN      ..I... 20
PEDESTAL     ...I... 32
HUE          ...I...  0
             -      +
DISPLAY      ALARM
PIX OFF      |
COMMUNICATION COAX
CAMERA RESET →PUSH SET
SER.NO. XXXXXXXX
RET TOP END
```

16. Chroma level adjustment [CHROMA GAIN]

Press the [RIGHT] or [LEFT] button to adjust the color density of the camera image. When the level indicator moves in the “+” direction, the color becomes deeper, and when the level indicator moves in the “-” direction, the color becomes lighter. Be sure to view a vector chromaticity indicator or a video monitor when the adjustment is performed.

17. Aperture level adjustment [AP GAIN]

Press the [RIGHT] or [LEFT] button to adjust the image quality. When the level indicator moves in the “+” direction, the image becomes sharper, and when the level indicator moves in the “-” direction, the image becomes softer. Be sure to view a video monitor when the adjustment is performed.

Note:

- Moire (interference fringes) may be observed when shooting a subject with fine pattern such as a carpet or a curtain. In such a case, move the indicator in the “-” direction to reduce moire.
-

18. Pedestal level adjustment [PEDESTAL]

Press the [RIGHT] or [LEFT] button to adjust the pedestal level of the camera. When the level indicator moves in the “+” direction, the image becomes brighter, and when the level indicator moves in the “-” direction, the image becomes darker. Be sure to view a video monitor when the adjustment is performed.

19. Chroma phase (hue) adjustment [HUE]

Press the [RIGHT] or [LEFT] button to adjust the hue of the camera image. Be sure to view a vector chromaticity indicator or a video monitor when the adjustment is performed.

Note:

- Holding down the [RIGHT] and [LEFT] buttons for more than 2 seconds simultaneously restores the settings of “CHROMA GAIN”, “AP GAIN”, “PEDESTAL”, and “HUE” to the default settings.
-

20. Display Settings [DISPLAY]

Move the cursor to “DISPLAY”, and press the [RIGHT] or [LEFT] button to change display settings.

OFF: Alarm display is disabled.

ALARM (default): Alarm display is activated.



Alarm display (“MOTION DET”, “SCENE CHANGE”)

21. Pixel compensation [PIX OFF]

Flaws of pixel in the displayed camera image are corrected. Up to 16 points can be corrected.
Follow the procedure below.

“SPECIAL SETUP” screen

```
***SPECIAL SETUP**
CHROMA GAIN  ...I...160
AP GAIN      ..I... 20
PEDESTAL    ...I... 32
HUE         -..I... 0
            +
DISPLAY      ALARM
PIX OFF*
COMMUNICATION COAX
CAMERA RESET →PUSH SET
SER.NO. XXXXXXXX
RET TOP END
```

“PIX OFF” screen

```
***PIX OFF**
 1   2   3   4
 5   6   7   8
 9  10  11  12
13  14  15  16

000 000
DEL          1
RET TOP END
```

Pixel compensation positioning screen

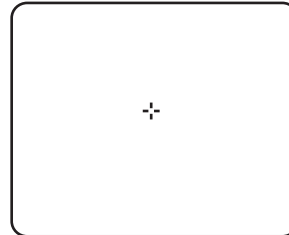

Step 1

Move the cursor to “PIX OFF” and press the [SET] button.
→ The “PIX OFF” screen appears.

Step 2

Select a number (1 to 16) with which a pixel compensation point is registered and press the [SET] button.
→ The pixel compensation positioning screen appears.

Step 3

Press the [UP], [DOWN], [RIGHT] and [LEFT] buttons to move the crosshair cursor to the center of the flaw to be corrected and press the [SET] button.

→ The flaw is corrected and the pixel compensation point is registered. The “PIX OFF” screen appears again. An asterisk “*” is attached at the right side of the number when registration is completed. The coordinate is expressed in figures.

Note:

- To clear the registered pixel compensation point, move the cursor to “1” of the right of “DEL”, use the [RIGHT] and [LEFT] buttons to select the number with which the target pixel compensation point is registered and press the [SET] button. The registered pixel compensation point is cleared, and an asterisk “*” at the right side of the number disappears.

22. Communication setting [COMMUNICATION]

The required communication configuration is performed to use this unit integrated into the system with a receiver.

COAX (RCV): When using our receiver.

COAX (default): When not using any receiver.

23. Default resetting [CAMERA RESET]

The settings in the setup menu are restored to the default settings.

The default settings are restored by moving the cursor to “PUSH SET” of “CAMERA RESET” and holding down the [RIGHT], [LEFT] and [SET] buttons for more than 2 seconds simultaneously.

Note:

- The data of the back focus setting (page 21) and registered pixel compensation points is not cleared.

24. Serial number viewing [SER.NO.]

Displays the serial number of this product.

Camera language selection [LANGUAGE SETUP]

A language for the setup menu is selected from the following: The language selection can be made on the “LANGUAGE SETUP” screen displayed from the top screen.

Refer to page 5 for how to call up the screen.

“LANGUAGE SETUP” screen

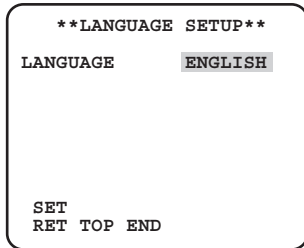

Move the cursor to “LANGUAGE” and press the [RIGHT] or [LEFT] button to select the target language, then move the cursor to “SET”, and press the [SET] button.

Select the target language from the following.

JAPANESE/ENGLISH (default)/**FRANÇAIS/ESPAÑOL/DEUTSCH/ITALIANO/РУССКИЙ/中文/PORTUGUÊS**

Note:

- When the language is changed, the specified camera title is cleared.
-

Shortcut operation

Use of a system controller with the “Camera function” button allows users to perform the shortcut settings with use of the numeric keypad and camera function button. The available shortcut operations with this unit are shown as follows.

System controller operation	Setting contents
[9] + [0] + [Camera function]	Black-and-white control (D&N) ON
[9] + [1] + [Camera function]	Black-and-white control (D&N) OFF
[9] + [2] + [Camera function]	Black-and-white control (D&N) AUTO1
[9] + [3] + [Camera function]	Camera title (CAMERA ID) ON
[9] + [4] + [Camera function]	Camera title (CAMERA ID) OFF
[9] + [8] + [Camera function]	Electronic zoom ON
[9] + [9] + [Camera function]	Electronic zoom OFF
[1] + [6] + [8] + [Camera function]	Black-and-white control (D&N) AUTO2
[1] + [6] + [9] + [Camera function]	Iris of lens (IRIS) OPEN
[1] + [7] + [0] + [Camera function]	Iris of lens (IRIS) CLOSE
[1] + [7] + [1] + [Camera function]	Electronic shutter (SHUTTER) ON
[1] + [7] + [2] + [Camera function]	Electronic shutter (SHUTTER) OFF
[1] + [7] + [3] + [Camera function]	Electronic shutter speed, 1 step faster
[1] + [7] + [4] + [Camera function]	Electronic shutter speed, 1 step slower
[1] + [7] + [5] + [Camera function]	Gain adjustment (AGC) ON
[1] + [7] + [6] + [Camera function]	Gain adjustment (AGC) OFF
[1] + [7] + [7] + [Camera function]	Electronic sensitivity up (SENS UP) FIX ON
[1] + [7] + [8] + [Camera function]	Electronic sensitivity up (SENS UP) FIX OFF
[1] + [7] + [9] + [Camera function]	Electronic sensitivity, 1 step up (FIX)
[1] + [8] + [0] + [Camera function]	Electronic sensitivity, 1 step down (FIX)
[1] + [8] + [1] + [Camera function]	Electronic sensitivity up (SENS UP) AUTO ON
[1] + [8] + [2] + [Camera function]	Electronic sensitivity up (SENS UP) AUTO OFF
[1] + [8] + [3] + [Camera function]	Electronic sensitivity, 1 step up (AUTO)
[1] + [8] + [4] + [Camera function]	Electronic sensitivity, 1 step down (AUTO)
[1] + [9] + [0] + [Camera function]	Time for switching at D&N AUTO, 2 seconds
[1] + [9] + [1] + [Camera function]	Time for switching at D&N AUTO, 10 seconds
[1] + [9] + [2] + [Camera function]	Time for switching at D&N AUTO, 30 seconds
[1] + [9] + [3] + [Camera function]	Time for switching at D&N AUTO, 60 seconds
[2] + [0] + [1] + [Camera function]	Image stabilizer (STABILIZER) ON
[2] + [0] + [2] + [Camera function]	Image stabilizer (STABILIZER) OFF
[2] + [1] + [3] + [Camera function]	Scene file 1
[2] + [1] + [4] + [Camera function]	Scene file 2
[2] + [1] + [5] + [Camera function]	Gain (AGC), 1 step up
[2] + [1] + [6] + [Camera function]	Gain (AGC), 1 step down

**Panasonic System Communications Company of North America,
Unit of Panasonic Corporation of North America**

www.panasonic.com/business/

For customer support, call 1.800.528.6747

Two Riverfront Plaza, Newark, NJ 07102-5490

Panasonic Canada Inc.

5770 Ambler Drive, Mississauga, Ontario, L4W 2T3 Canada

(905)624-5010

www.panasonic.ca